

Crystal Unit

Product	TFX-04
Model number	ST-RIVER-1610-5PF-80K
Nominal frequency	32.768 kHz
Overtone order [Cut]	Fundamental [X-cut]
Load capacitance	5 pF
Equivalent series resistance	80 kΩ Max.
Frequency tolerance	±20 ppm (@25°C)

IC

Manufacturer	STMicroelectronics
Model	STM32F410××

Recommended Condition for Stable Oscillation

Negative resistance	240 kΩ Min.
Drive level	0.5 μW Max.

Circuit Diagram

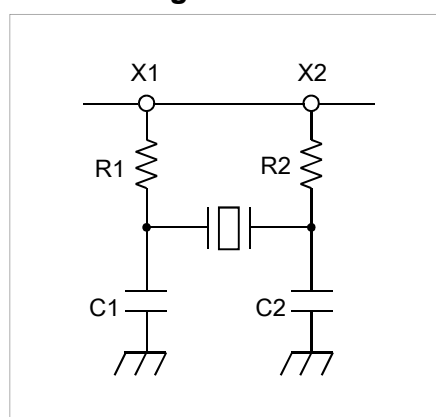

Evaluation Result

R1 [Ω]	R2 [Ω]	C1 [pF]	C2 [pF]	Negative resistance [kΩ]	Drive level [μW]	Frequency deviation [ppm]
0	0	4.3	4.3	250	0.1 Max.	-3.3

* Ambient temperature: +25°C / Supply voltage: USB

RIVER

リバーエレクトック株式会社
RIVER ELETEC CORPORATION

<http://www.river-ele.co.jp/>

〒407-8502 山梨県韮崎市富士見ヶ丘2丁目1番11号
TEL(0551)22-1211(代) FAX(0551)22-6645

東京営業所
大阪営業所

River Electronics(Singapore)Pte.Ltd
Taiwan River Co.,Ltd.
Xi'an River Electronics Corporation
Shenzhen Liaison Office

TEL(03)3377-5444(代) FAX(03)3374-2865
TEL(06)6998-4888(代) FAX(06)6998-4899

TEL: +65-6258-7874 FAX: +65-6258-7366
TEL: +886-2-8988-2811 FAX: +886-2-2983-4785

TEL: +86-755-86528590 FAX: +86-755-86528590