

Crystal Unit

Product	FCX-05
Model number	12.000MHZ-J21138
Nominal frequency	12.000000 MHz
Overtone order [Cut]	Fundamental [AT-cut]
Load capacitance	6 pF
Equivalent series resistance	200Ω Max.
Frequency tolerance	±30 ppm (@25°C)

IC

Manufacturer	Renesas Electronics
Series	RL78/G14
Model	R5F104xxx

Recommended Condition for Stable Oscillation

Negative resistance	1000Ω Min.
Drive level	200 μW Max.

Circuit Diagram

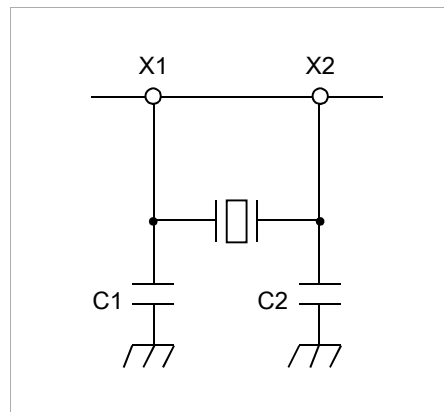

Evaluation Result

Flash operation mode of RL78/G14	C1 [pF]	C2 [pF]	VDD [V]	Negative resistance [Ω]	Drive level [μW]	Frequency deviation [ppm]
HS (high speed main) mode	6	6	+2.4	1410	70	+2.1
			+2.70	1410	70	+2.2
			+2.75	1410	70	+2.2
			+5.5	1410	70	+2.5
			+6.0	1410	70	+2.5

* Ambient temperature: 25°C

RIVER

リバーエレクトック株式会社
RIVER ELETEC CORPORATION

<http://www.river-ele.co.jp/>

〒407-8502 山梨県韮崎市富士見ヶ丘2丁目1番11号
TEL(0551)22-1211(代) FAX(0551)22-6645

東京営業所
大阪営業所

River Electronics(Singapore)Pte.Ltd
Taiwan River Co.,Ltd.
Xi'an River Electronics Corporation
Shenzhen Liaison Office

TEL(03)3377-5444(代) FAX(03)3374-2865
TEL(06)6998-4888(代) FAX(06)6998-4899

TEL: +65-6258-7874 FAX: +65-6258-7366
TEL: +886-2-8988-2811 FAX: +886-2-2983-4785

TEL: +86-755-86528590 FAX: +86-755-86528590